

## Feld contra Straße

## Terra Trac Laufbänder als Beitrag zum Bodenschutz

Dr. Eberhard Nacke

VDI Köln, 17.1.2018

**CLAAS**



Große Maschinen = mehr Bodenschädigung?

Motivation  
Knappe Ressourcen

Schlagkraft ermöglicht  
Arbeit bei  
geeigneter Witterung



# Motivation

- Zeitgerechte Bearbeitung ermöglichen
- Bodenschutz



# Konkurrierende Ziele

Gesetzgebungen oder Verordnungen sind untereinander nicht immer konfliktfrei



- ***Straßenverkehrszulassungsordnung***
- ***Bodenschutz***





# Einzelreifen – Raupen Tester



Q



# Messung der Bodenverformung

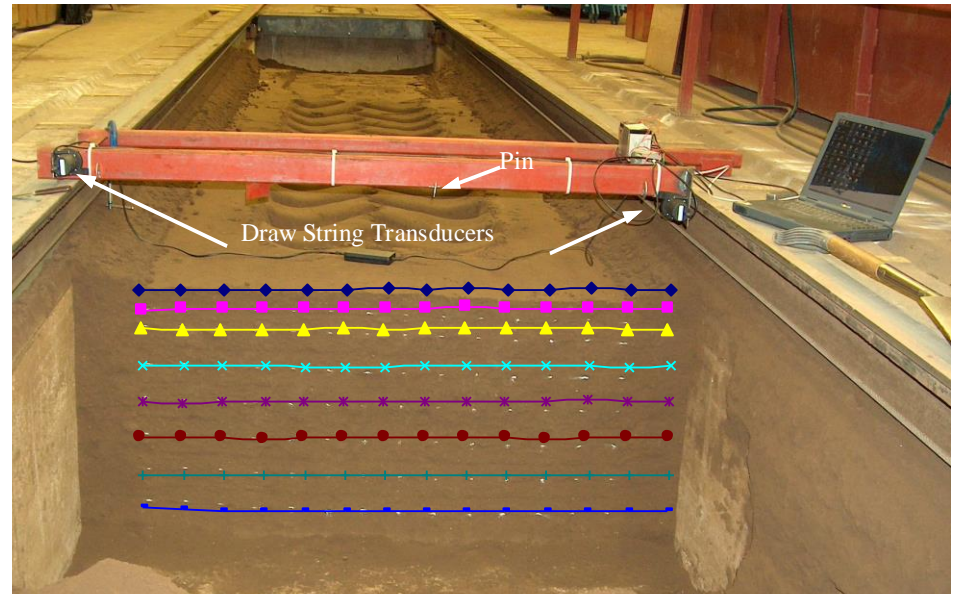
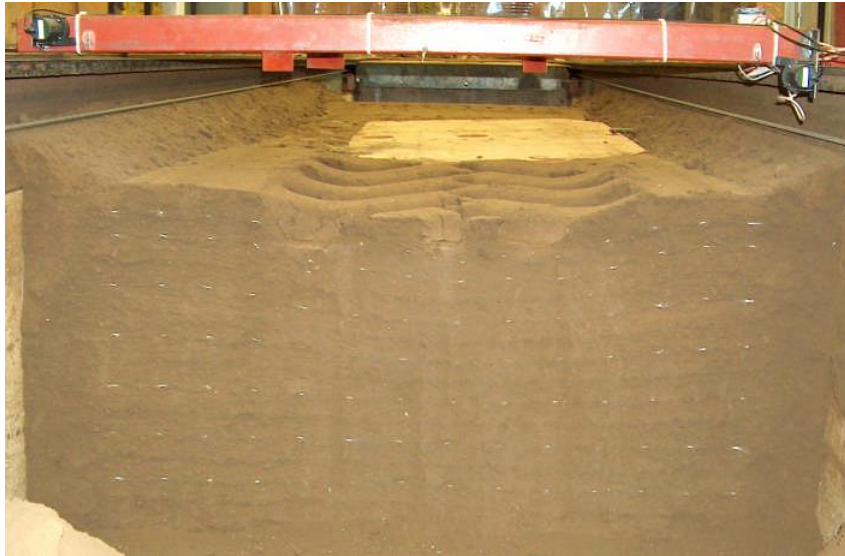

# Bodenbewegung

Reifen, 800 mm breit, 10.5 t Last und 2.5 bar

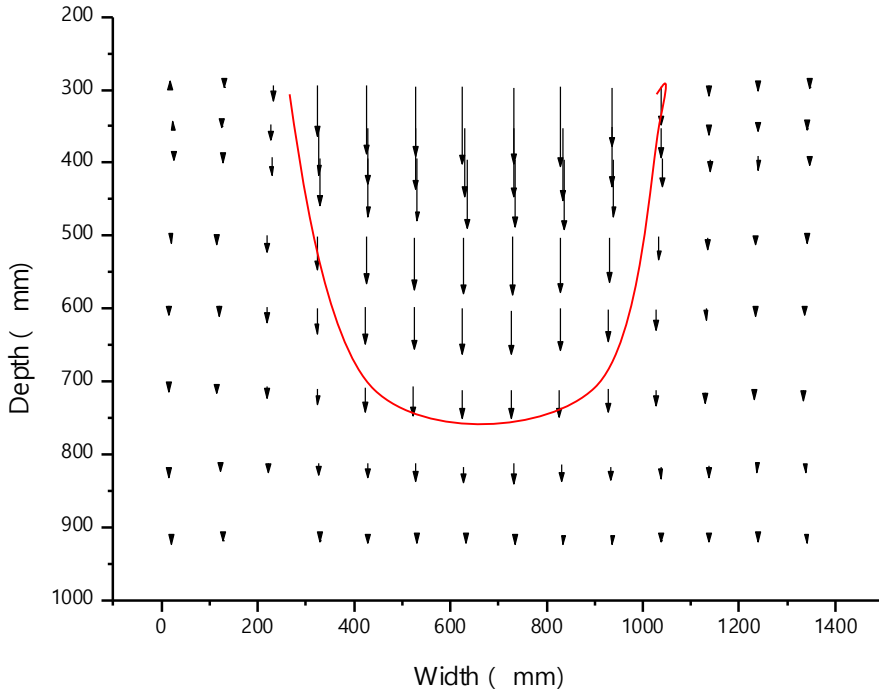

Raupe, 650 mm breit und 12 t Last

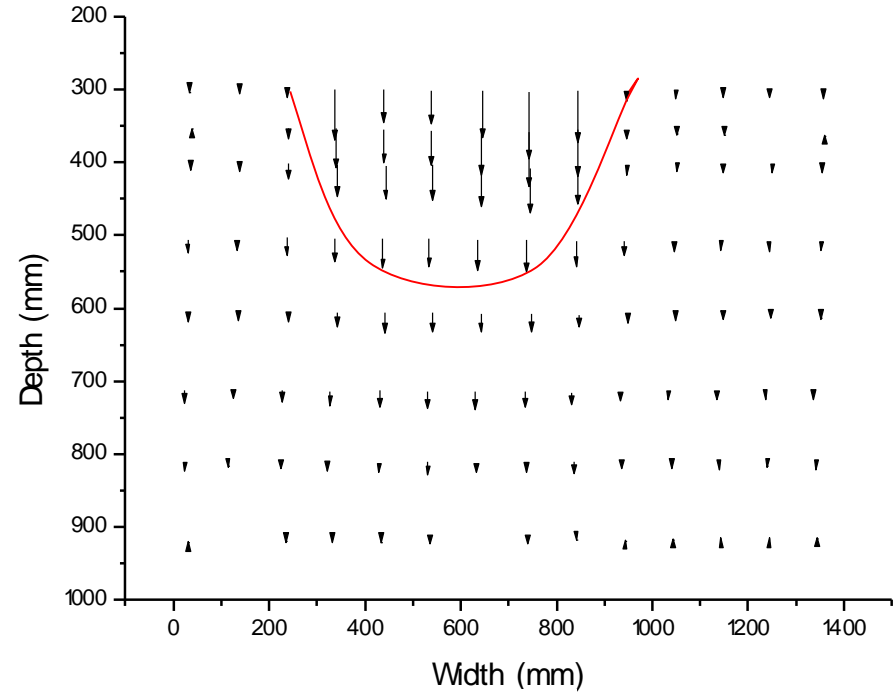



## Formschluss

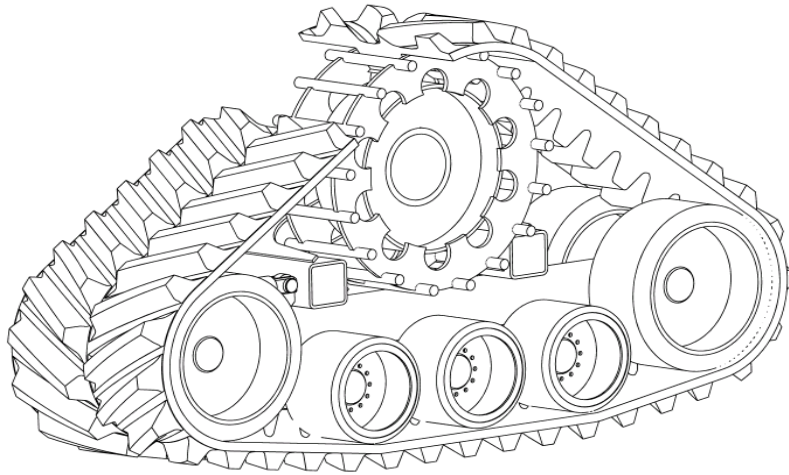

## Kraftschluss

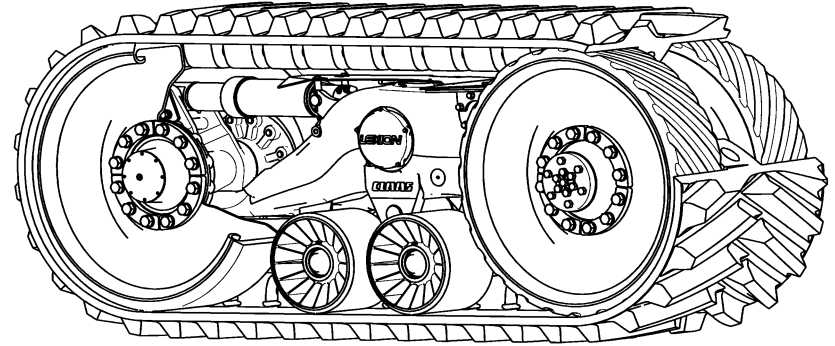

# Bandspannung 8t

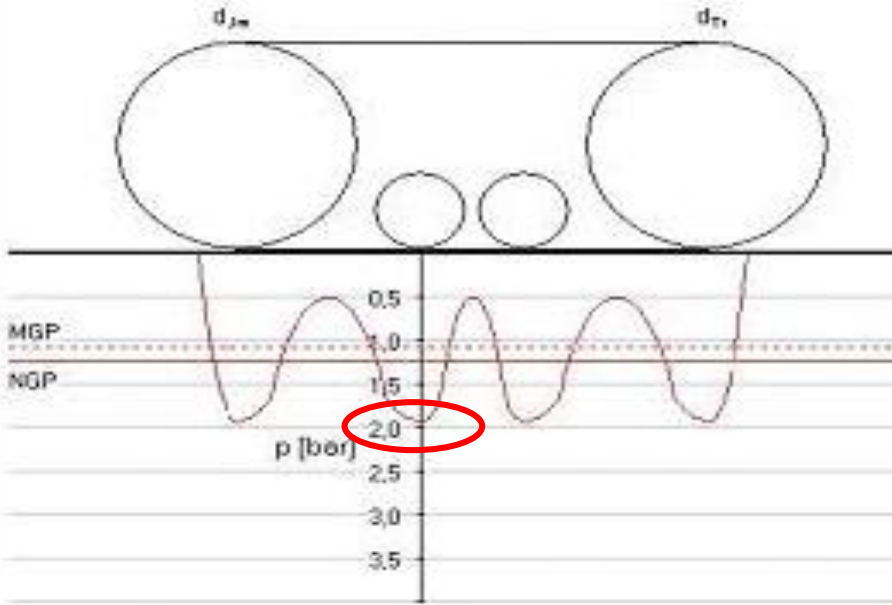

# Bandspannung 16t

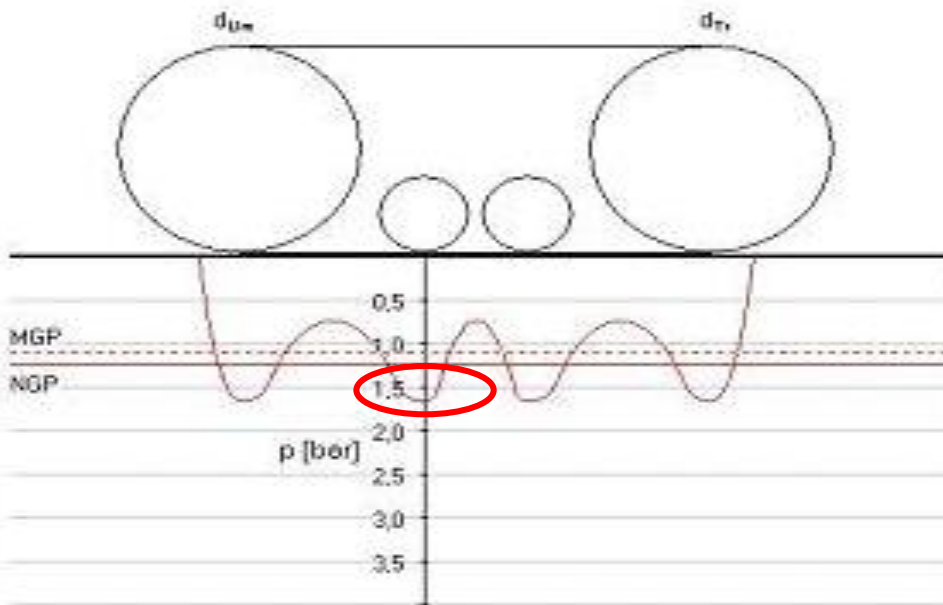

Stephan Bleischwitz with the approach of Bekker/Wong, loan...

Schmal auf der Straße und wenig Bodendruck...

...aber was passiert mit der Grasnarbe auf Grünland?



# Feldhäcksler im Grünlandeinsatz

## Motivation

- Befahrbarkeit
- Bodenverdichtung auf Grünland
- Schonung der Grasnarbe bei Kurvenfahrt

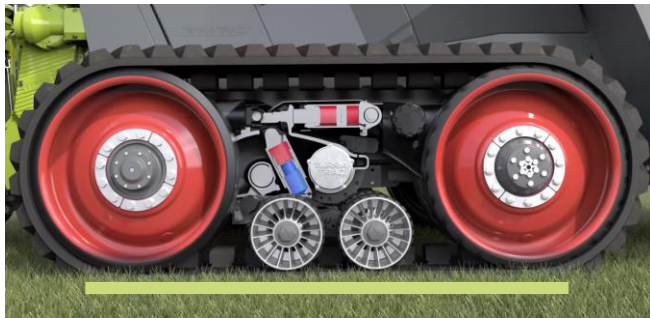

### Tires traction limitations in heavy pulling conditions

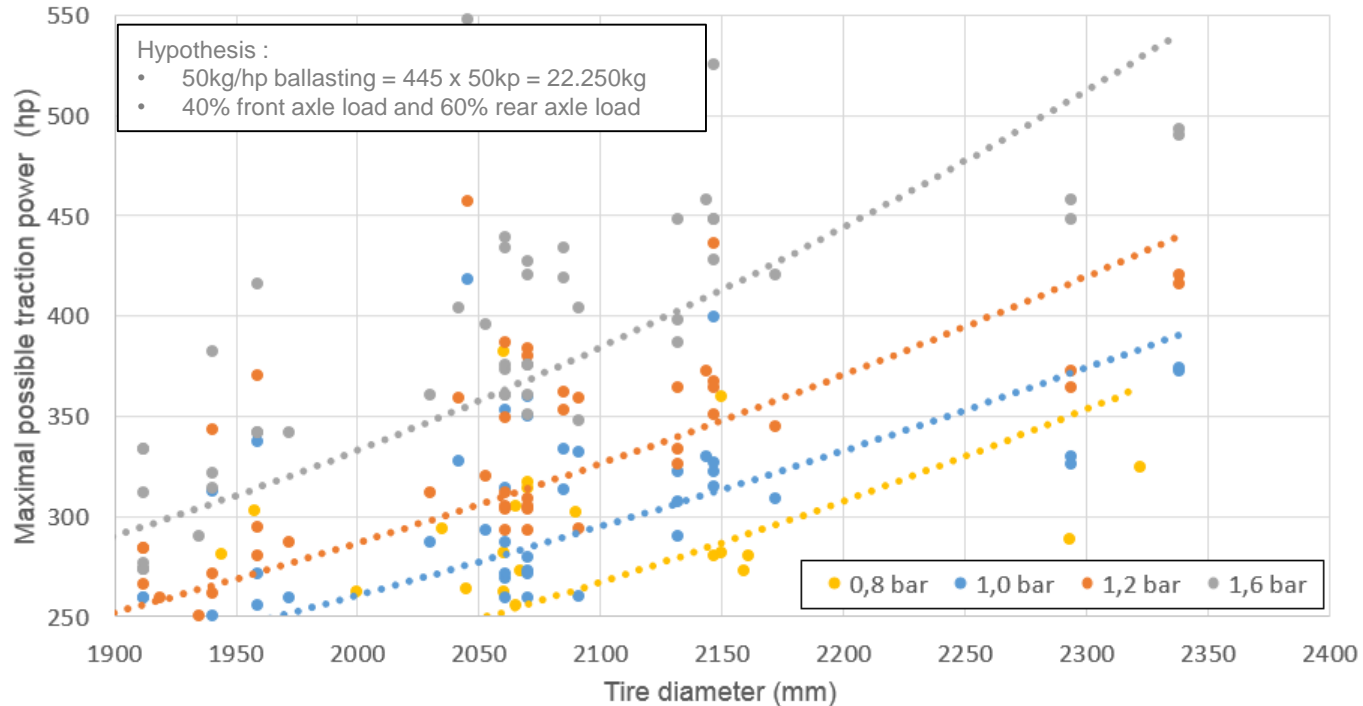

Source : Dr Thomas Fedde – CLAAS Tractor Advanced Engineering

# Reifen oder Raupen?

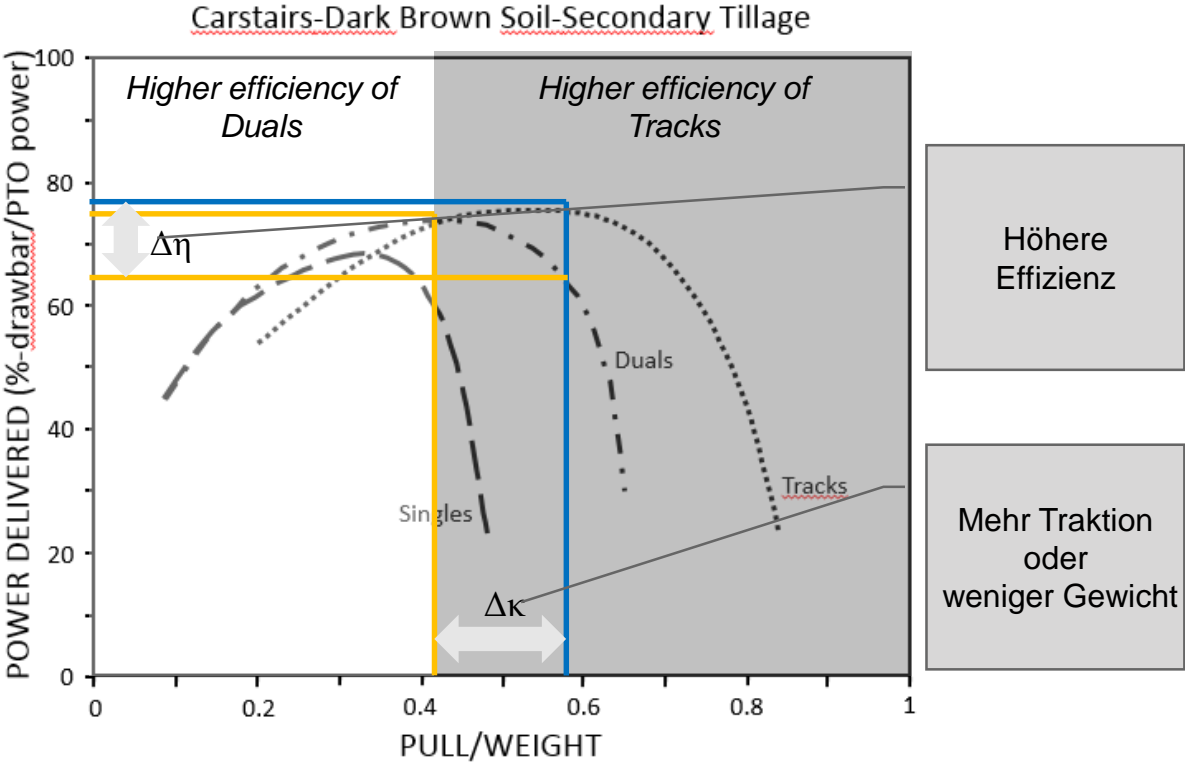

Power Delivery Efficiency vs. Pull to Weight at 16400 kg total tractor weight

Source : Reed J. Turner: SINGLE, DUAL AND TRIPLE TIRES AND RUBBER BELT TRACKS IN PRAIRIE SOIL CONDITIONS, Alberta Farm Machinery Research Centre, 1993



## Motivation

- ❖ Wie bringt man die Kraft auf den Boden?
- Reifenverschleiß
- Lenkeigenschaften
- Fahrkomfort
- Bodenschutz
- Straßenzulassung

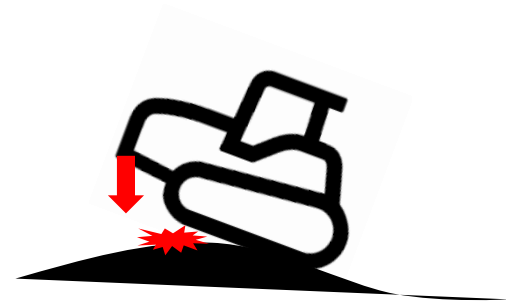
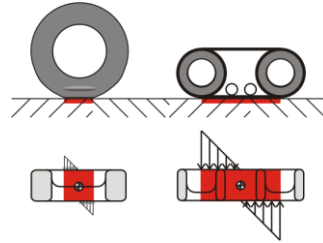

## Current market situation in the 350 – 500hp range

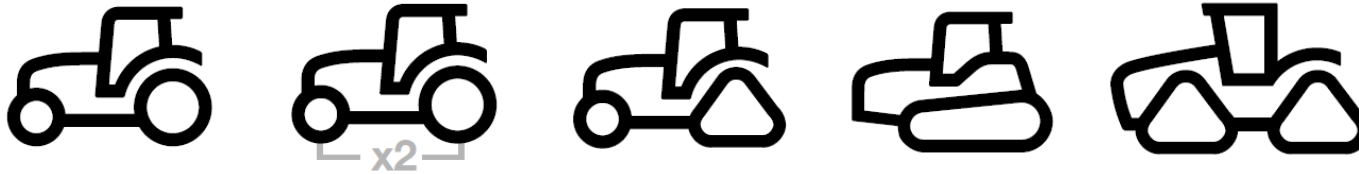

	Wheels		Current Half Track	Tracks	
	Single	Duals		Two Tracks	Four Tracks
Steerability	++	+	-	--	+
Versatility	++	-	+	--	--
Driving on road	++	--	+	-	-
Mobility in the wet	--	-	+	++	++
Comfort	+	+	-	--	-
Traction Efficiency	--	-	+	++	++
Ground Pressure	--	+	+	++	++
Costs	++	++	+	-	--



## 6. Integration on the AXION 900

### The Solution

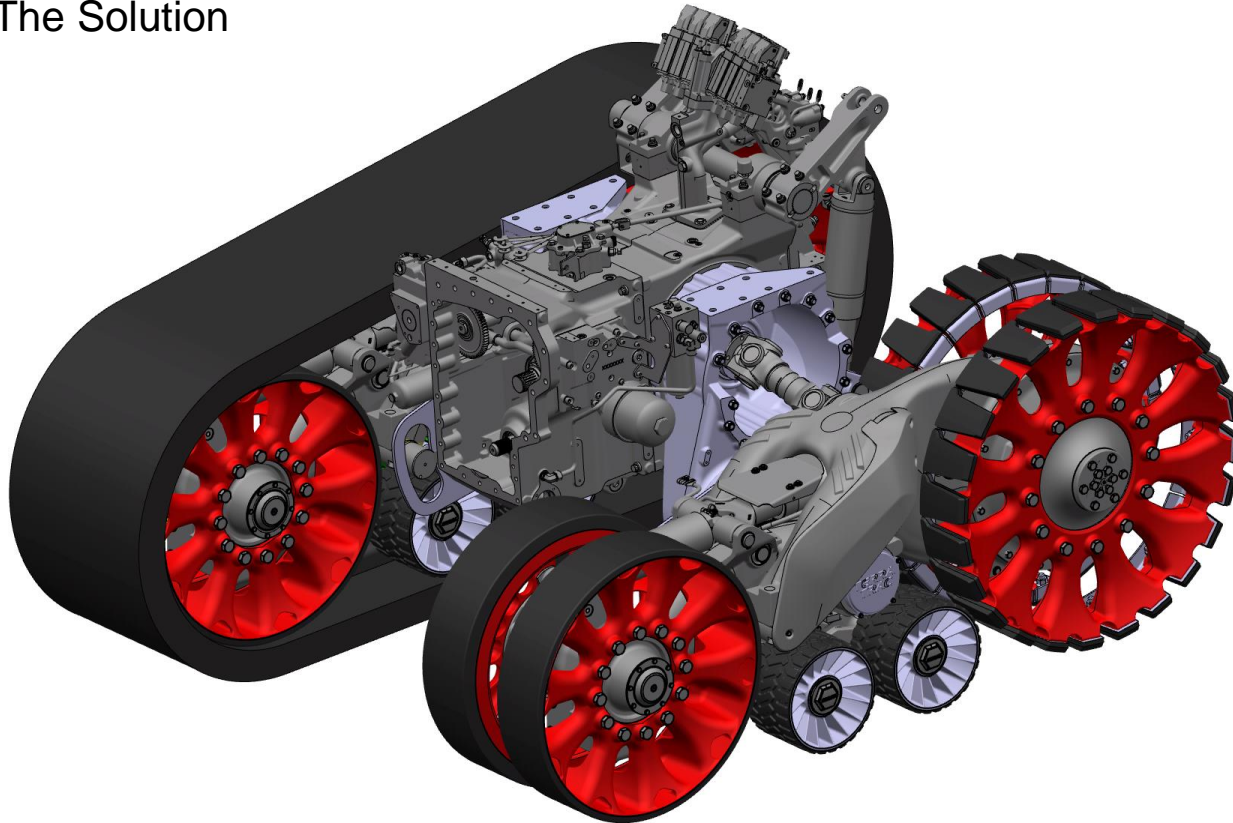

# TERRA TRAC – Entwicklung



- Prototypen Ende der 80er Jahre
- Heute mehr als 10.000 Laufwerke im Markt

